

Specifications

Nominal Voltage		12 V
Capacity (25°C)	10HR(10.8V)	40 Ah
	5HR(10.5V)	35Ah
	1HR(9.60V)	24.8Ah
Dimension	Length	197 ± 2mm (7.76inch)
	Width	165 ± 2mm (6.50inch)
	Height	170 ± 2mm (6.69inch)
	Total Height	170 ± 2mm (6.69inch)
Approx. Weight		12.8kg (28.2lbs) ± 4%
Terminal type		T4/T9
Internal resistance (Fully charged, 25°C)		Approx. 8.5mΩ
Capacity affected by temperature (10HR)	40°C	102%
	25°C	100%
	0°C	85%
	-15°C	65%
Self-discharge (25°C)	3 month	Remaining Capacity: 91%
	6 month	Remaining Capacity: 82%
	12 month	Remaining Capacity: 65%
Nominal operating temperature		25°C ± 3°C (77°F ± 5°F)
Operating temperature range	Discharge	-15°C ~ 50°C (5°F ~ 122°F)
	Charge	-10°C ~ 50°C (14°F ~ 122°F)
	Storage	-20°C ~ 50°C (-4°F ~ 122°F)
Float charging voltage(25°C)		13.50 to 13.80V Temperature compensation: -18mV/°C
Cyclic charging voltage(25°C)		14.50 to 14.90V Temperature compensation: -30mV/°C
Maximum charging current		12A
Terminal material		Copper
Maximum discharge current		400A(5 sec.)
Designed floating life(20°C)		10~12 years

- ◆ Absorbent glass mat technology;
- ◆ Recognized by UL & CE;
- ◆ ABS container.

Constant Current Discharge Characteristics (A, 25°C)

F.V/TIME	10min	15min	30min	60min	2h	3h	4h	5h	8h	10h	20h
9.60V	84.0	66.0	40.0	24.8	14.6	10.2	8.36	7.14	4.90	4.07	2.14
9.90V	81.5	64.4	39.2	24.4	14.5	10.1	8.31	7.10	4.87	4.06	2.13
10.2V	78.1	62.0	38.0	23.8	14.4	10.1	8.26	7.05	4.83	4.05	2.13
10.5V	74.8	59.9	37.1	23.3	14.2	10.0	8.20	7.00	4.80	4.03	2.11
10.8V	70.6	56.8	35.7	22.6	13.8	9.70	7.95	6.79	4.66	4.00	2.10

Constant Power Discharge Characteristics (Watt, 25°C)

F.V/TIME	10min	15min	30min	60min	2h	3h	4h	5h	8h	10h	20h
9.60V	907	725	449	283	169	120	98.4	84.4	58.2	48.6	25.7
9.90V	880	707	440	278	168	119	97.8	83.9	57.8	48.5	25.6
10.2V	844	681	426	271	167	118	97.1	83.3	57.4	48.4	25.5
10.5V	807	658	416	266	164	118	96.4	82.7	57.0	48.1	25.4
10.8V	762	623	401	258	160	114	93.5	80.3	55.3	47.8	25.2

Note: The above characteristics data can be obtained within three charge/discharge cycles.

MM1240(12V40Ah)



Dimensions

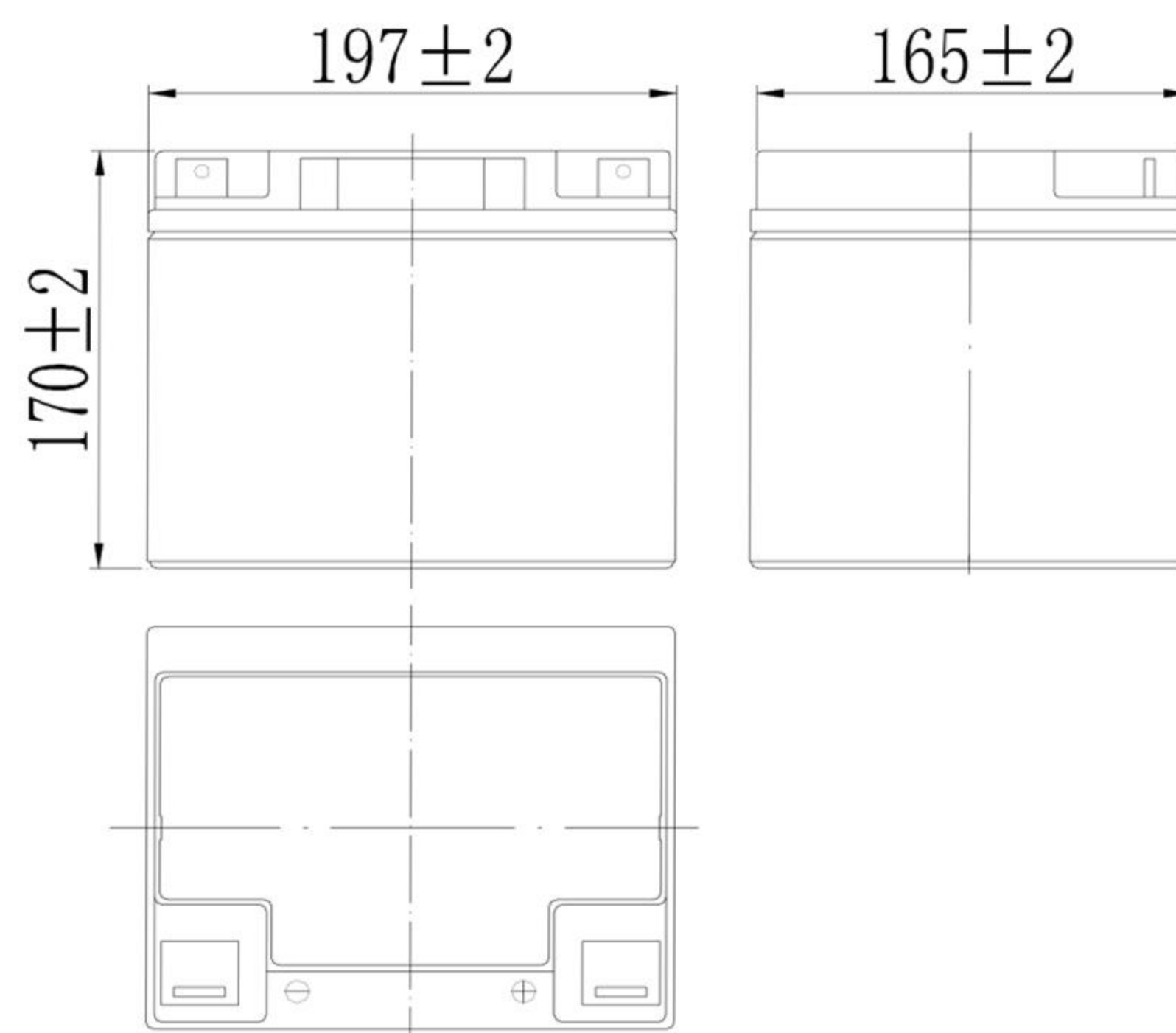

Terminal

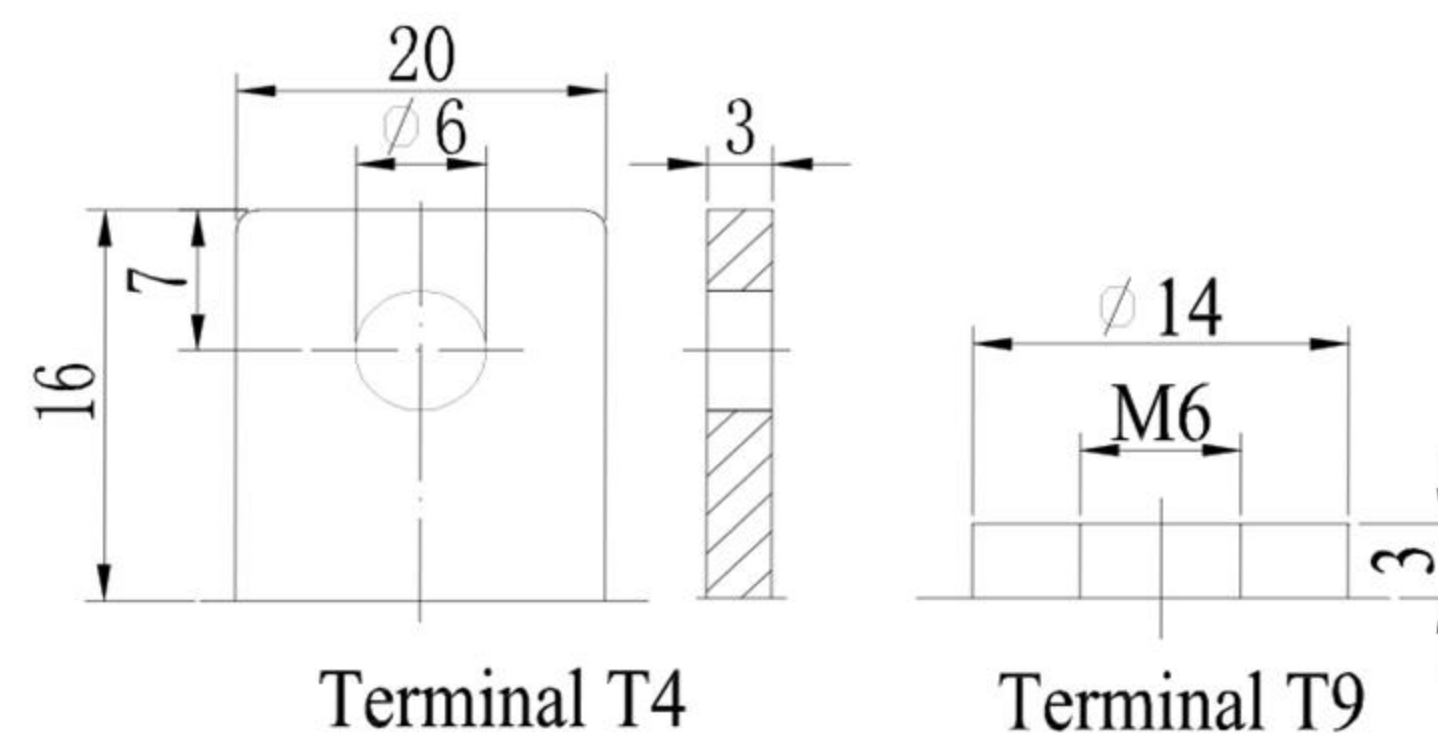

MEGA MAX

Specially Designed for UPS

MM1240(12V40Ah)

Discharge Characteristics(25°C)

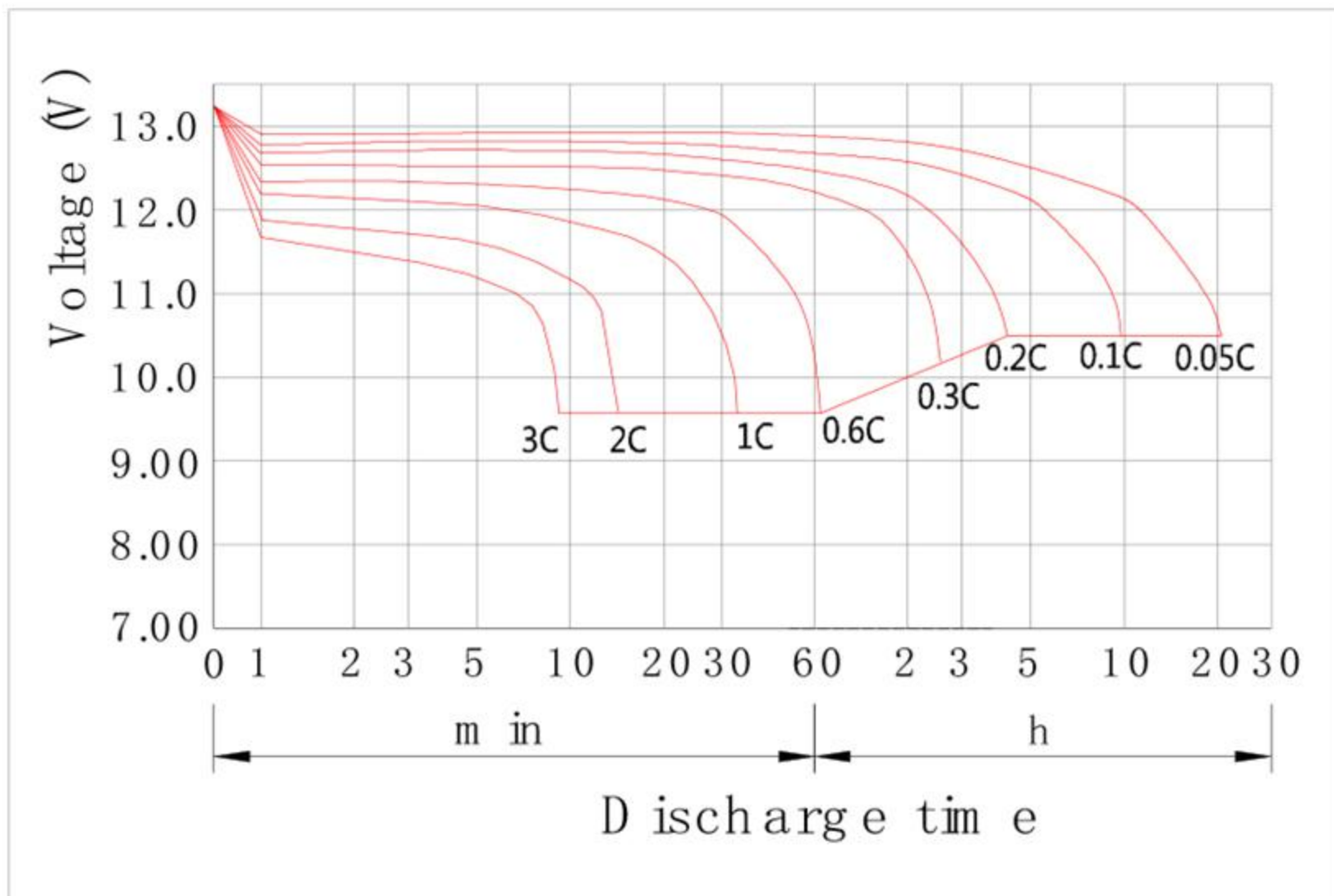

Charging Characteristics(25°C)

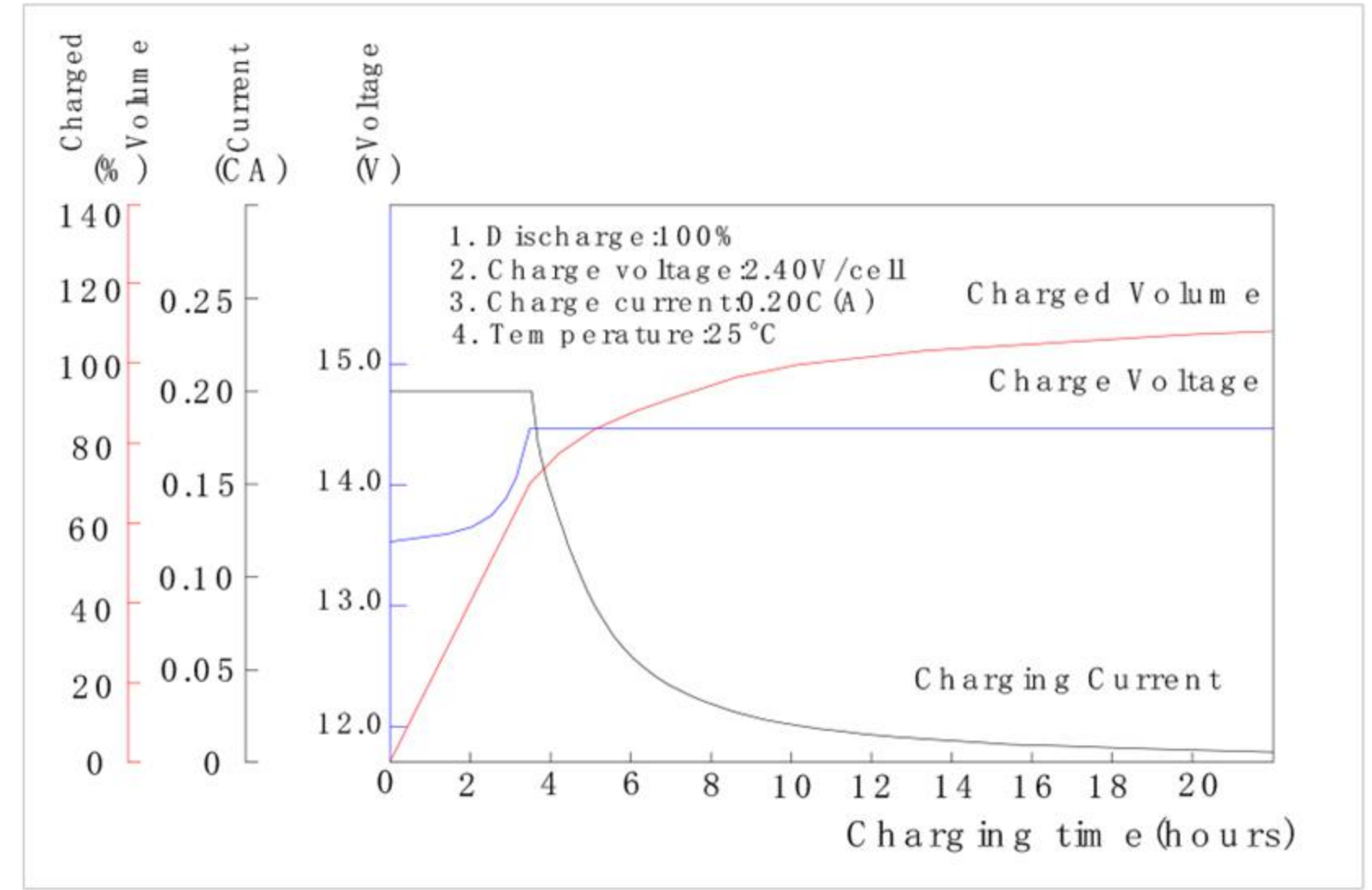

Effect of Temperature on Capacity

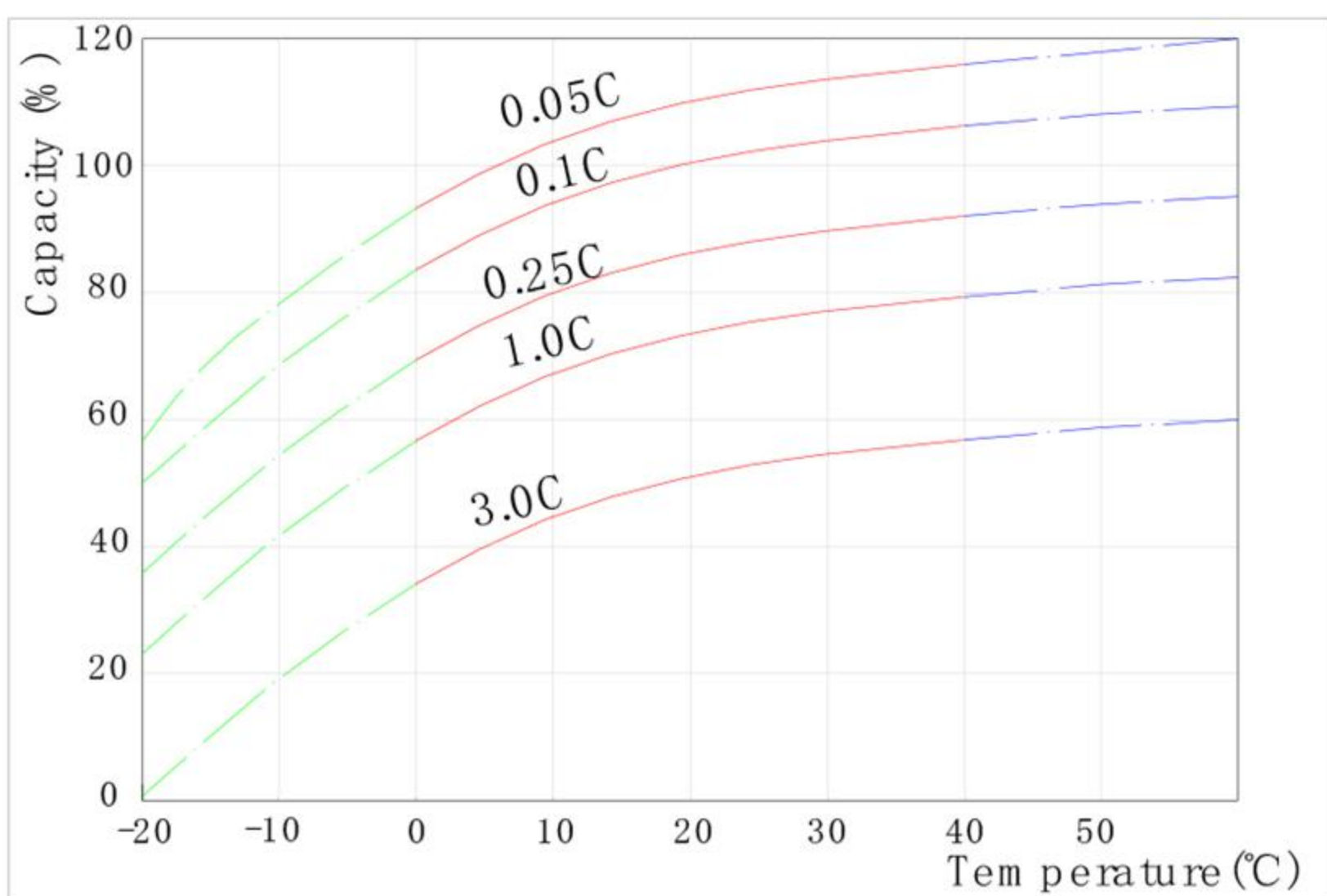

Self-discharge Characteristics

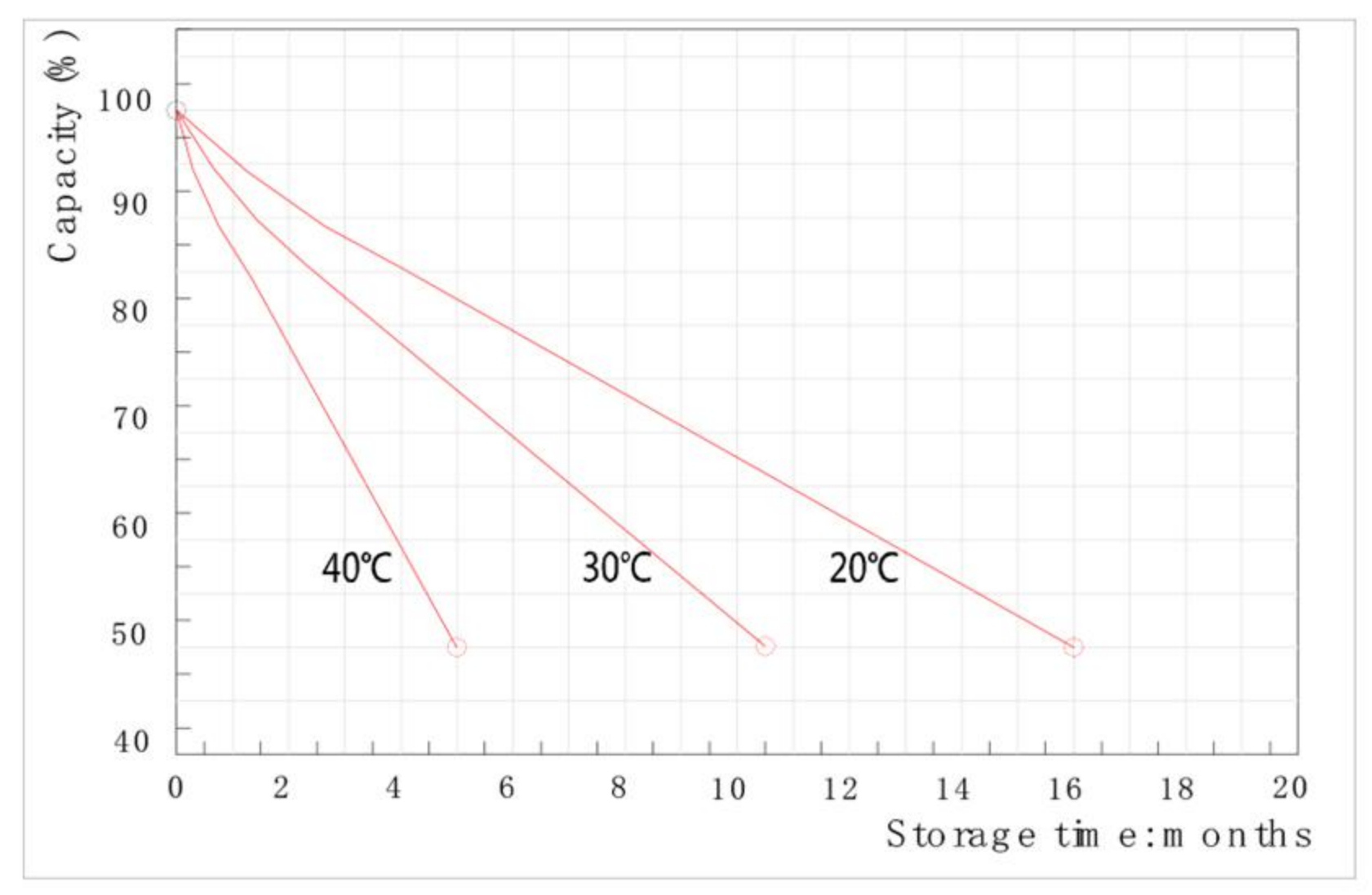

The Relationship for Open Circuit Voltage and Residual Capacity (25°C)

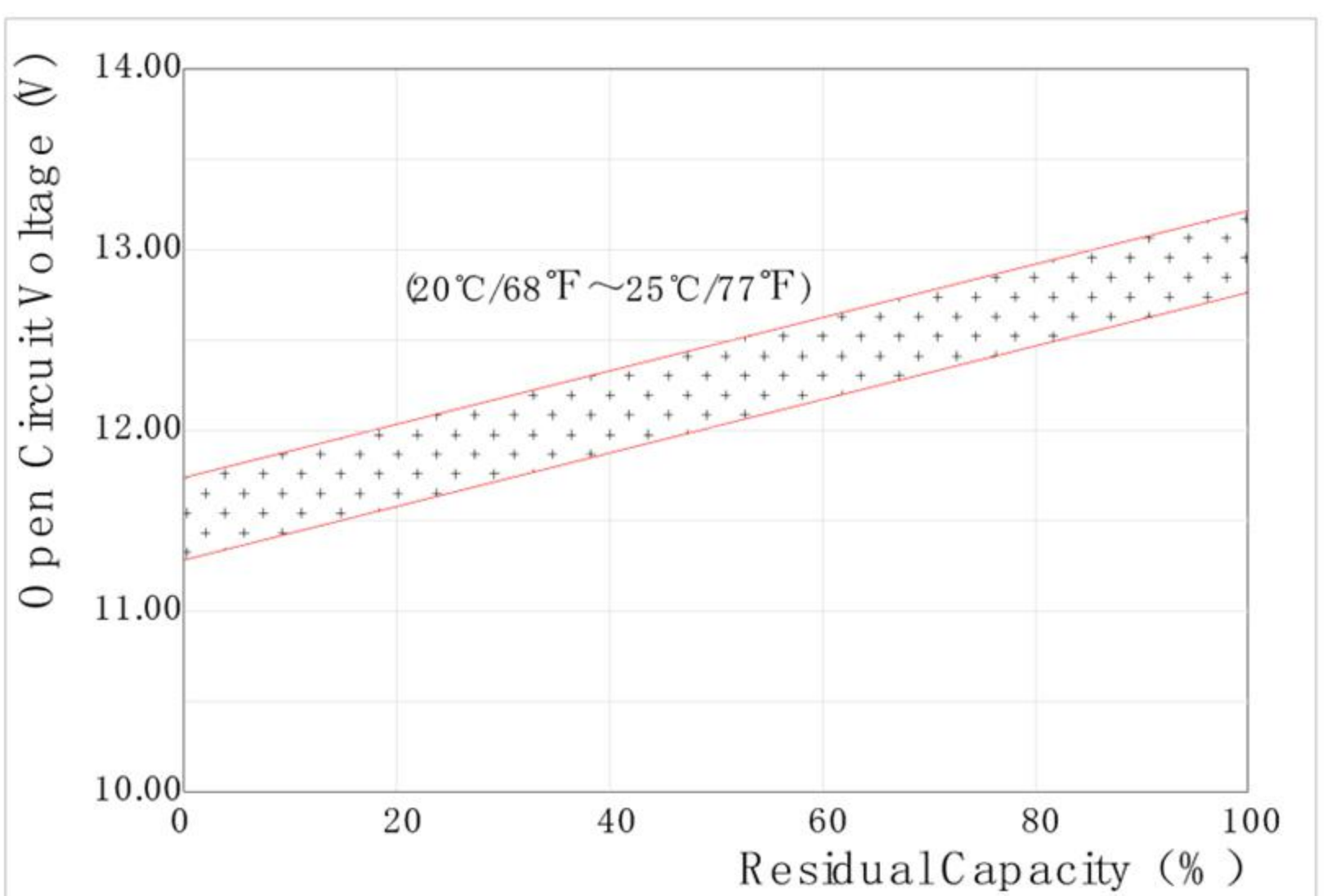

The Relationship for Charging Voltage and Temperature

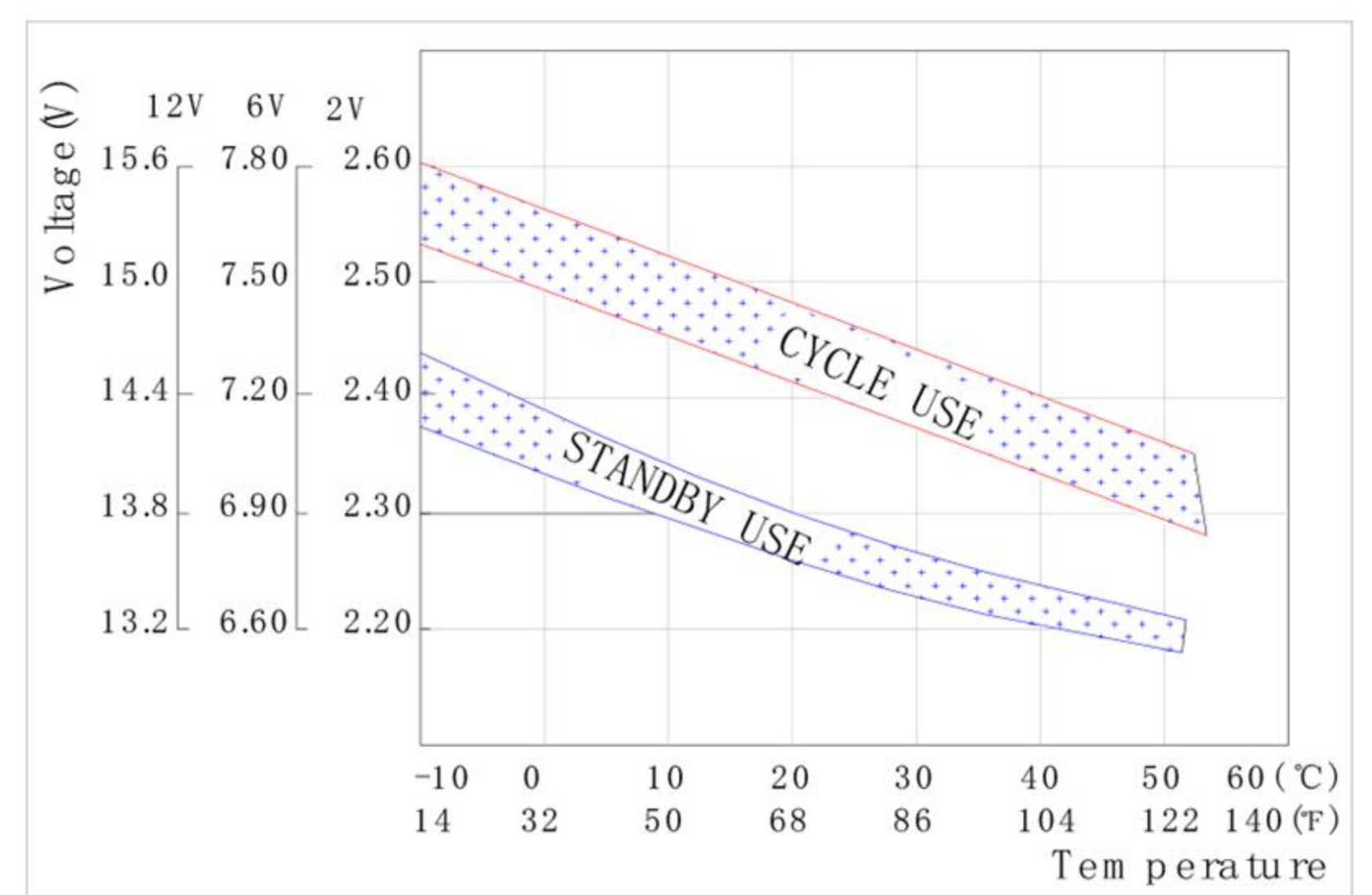

Floating Life on Temperature

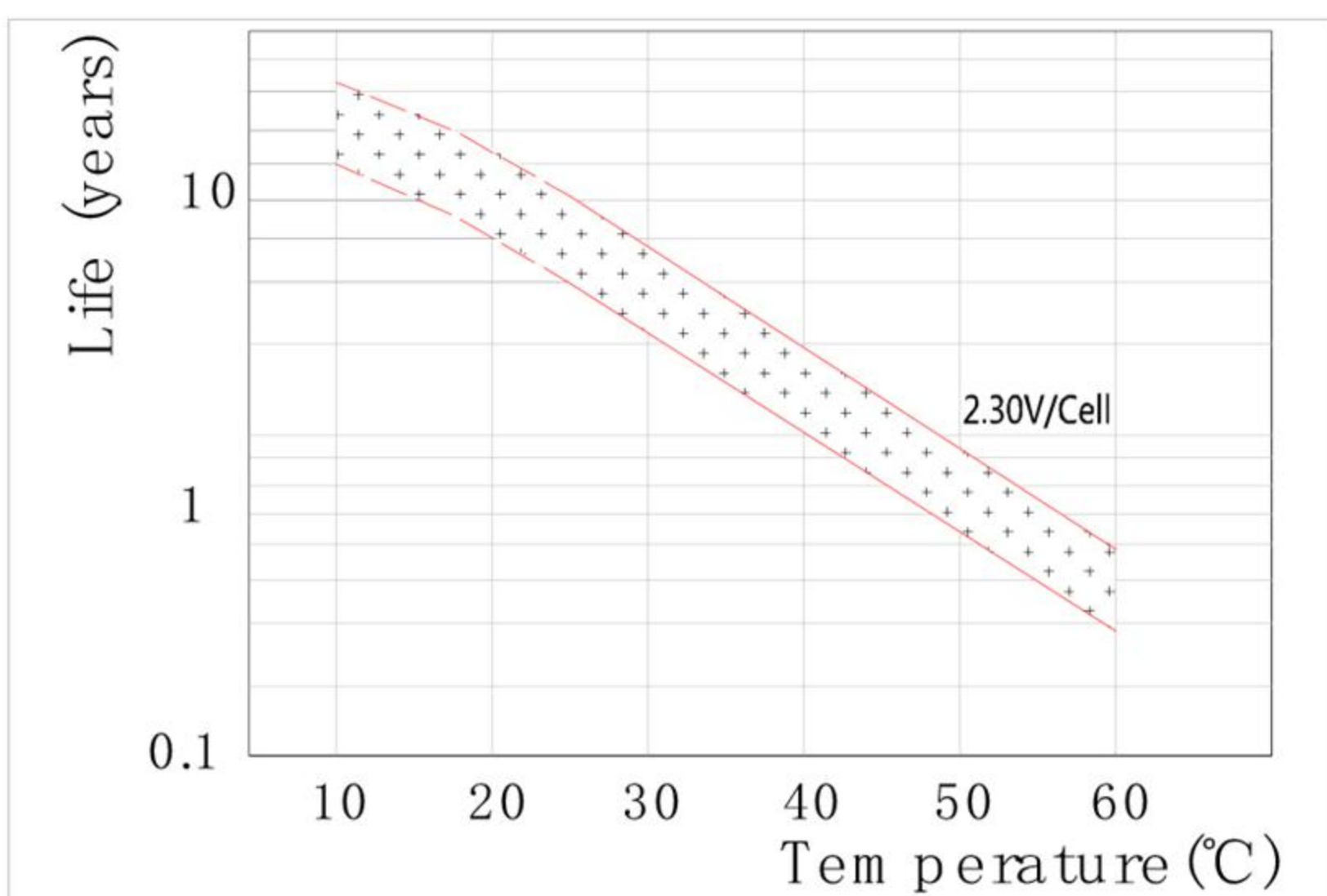

Cycle Life on D.O.D(25°C)

