

Specifications

Nominal Voltage		12 V
Capacity (25°C)	20HR(10.5V)	18Ah
	10HR(10.5V)	16.7Ah
	1HR(9.60V)	11.7Ah
Dimension	Length	181 ± 2mm (7.13inch)
	Width	77 ± 1mm (3.03inch)
	Height	167 ± 2mm (6.57inch)
	Total Height	167 ± 2mm (6.57inch)
Approx. Weight		5.3kg (11.7lbs) ± 4%
Terminal type		T3/T8
Internal resistance (Fully charged, 25°C)		Approx. 16mΩ
Capacity affected by temperature (20HR)	40°C	102%
	25°C	100%
	0°C	85%
	-15°C	65%
Self-discharge (25°C)	3 month	Remaining Capacity: 91%
	6 month	Remaining Capacity: 82%
	12 month	Remaining Capacity: 65%
Nominal operating temperature		25°C ± 3°C (77°F ± 5°F)
Operating temperature range	Discharge	-15°C ~ 50°C (5°F ~ 122°F)
	Charge	-10°C ~ 50°C (14°F ~ 122°F)
	Storage	-20°C ~ 50°C (-4°F ~ 122°F)
Float charging voltage(25°C)		13.60 to 13.80V Temperature compensation: -18mV/°C
Cyclic charging voltage(25°C)		14.50 to 14.90V Temperature compensation: -30mV/°C
Maximum charging current		5.4A
Terminal material		Copper
Maximum discharge current		270A(5 sec.)
Designed floating life(20°C)		8~10years

MM1218 (12V18Ah)



Dimensions

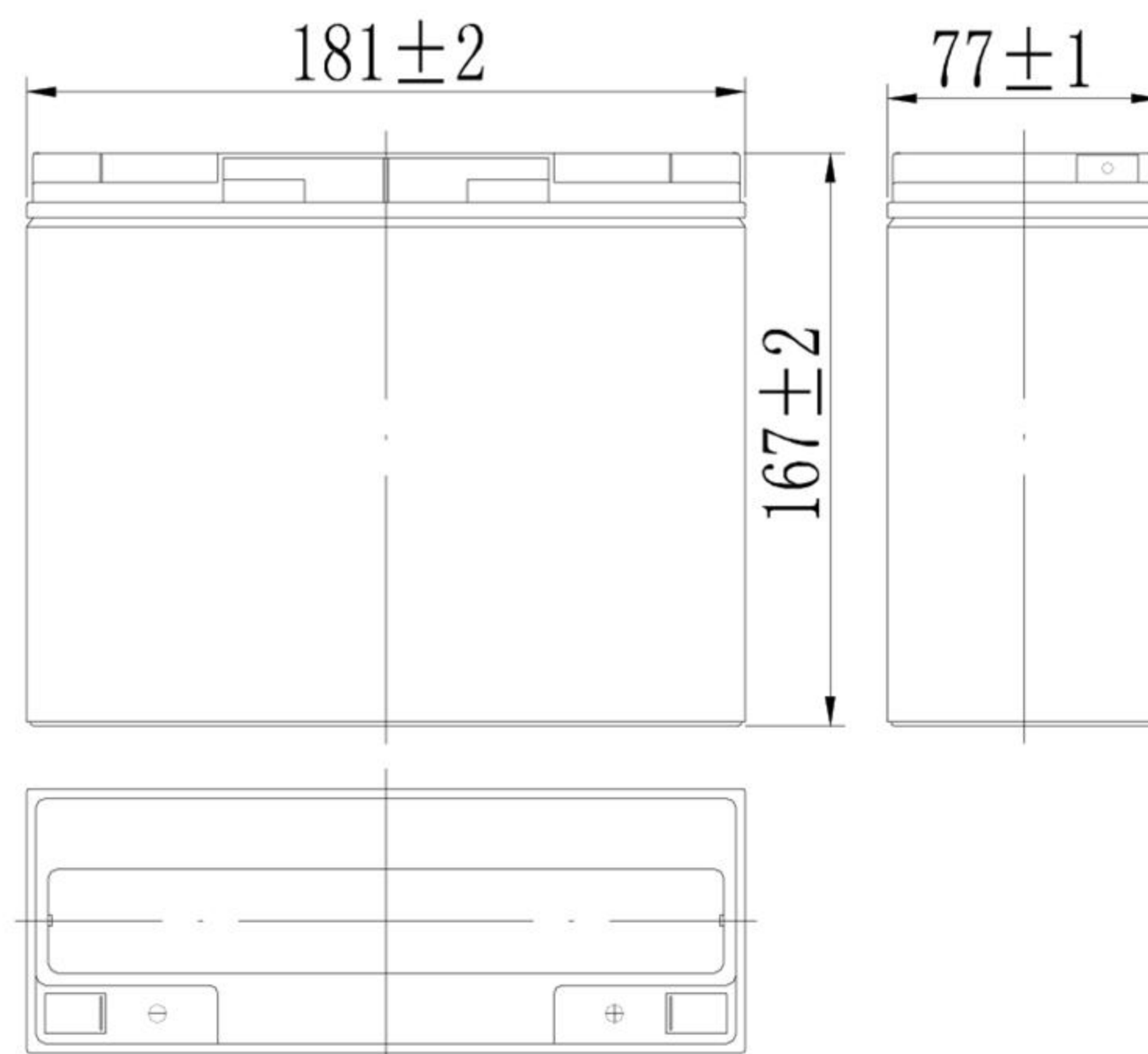

Terminal

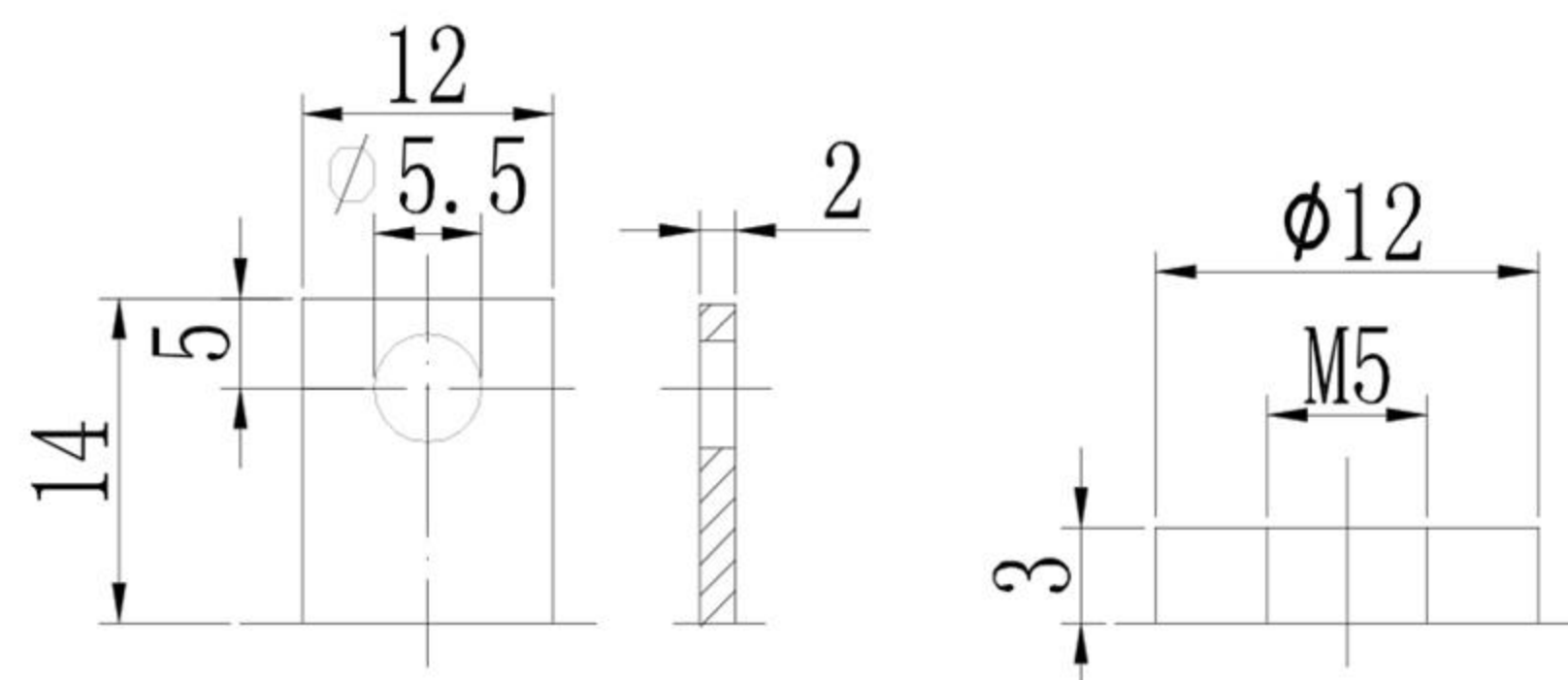

Terminal T3

Terminal T8

- ◆ Absorbent glass mat technology;
- ◆ Recognized by UL & CE;
- ◆ ABS container.

Constant Current Discharge Characteristics (A, 25°C)

F.V/TIME	10min	15min	30min	60min	2h	3h	4h	5h	8h	10h	20h
9.60V	43.2	34.2	19.1	11.7	6.39	4.59	3.67	3.12	2.02	1.70	0.91
9.90V	41.9	33.4	18.7	11.5	6.36	4.56	3.65	3.10	2.01	1.69	0.91
10.2V	40.2	32.1	18.1	11.2	6.30	4.53	3.63	3.08	1.99	1.68	0.91
10.5V	38.4	31.1	17.7	11.0	6.21	4.50	3.60	3.06	1.98	1.67	0.90
10.8V	36.3	29.4	17.0	10.7	6.05	4.37	3.49	2.97	1.92	1.64	0.88

Constant Power Discharge Characteristics (Watt, 25°C)

F.V/TIME	10min	15min	30min	60min	2h	3h	4h	5h	8h	10h	20h
9.60V	487	390	219	135	74.8	54.5	43.7	37.3	24.2	20.4	11.0
9.90V	473	381	214	133	74.4	54.2	43.5	37.0	24.1	20.3	10.9
10.2V	453	366	208	130	73.7	53.8	43.2	36.8	23.9	20.2	10.9
10.5V	434	354	203	127	72.6	53.5	42.9	36.5	23.8	20.1	10.8
10.8V	409	335	195	124	70.8	51.9	41.6	35.4	23.0	19.7	10.6

Note: The above characteristics data can be obtained within three charge/discharge cycles.

Discharge Characteristics(25°C)

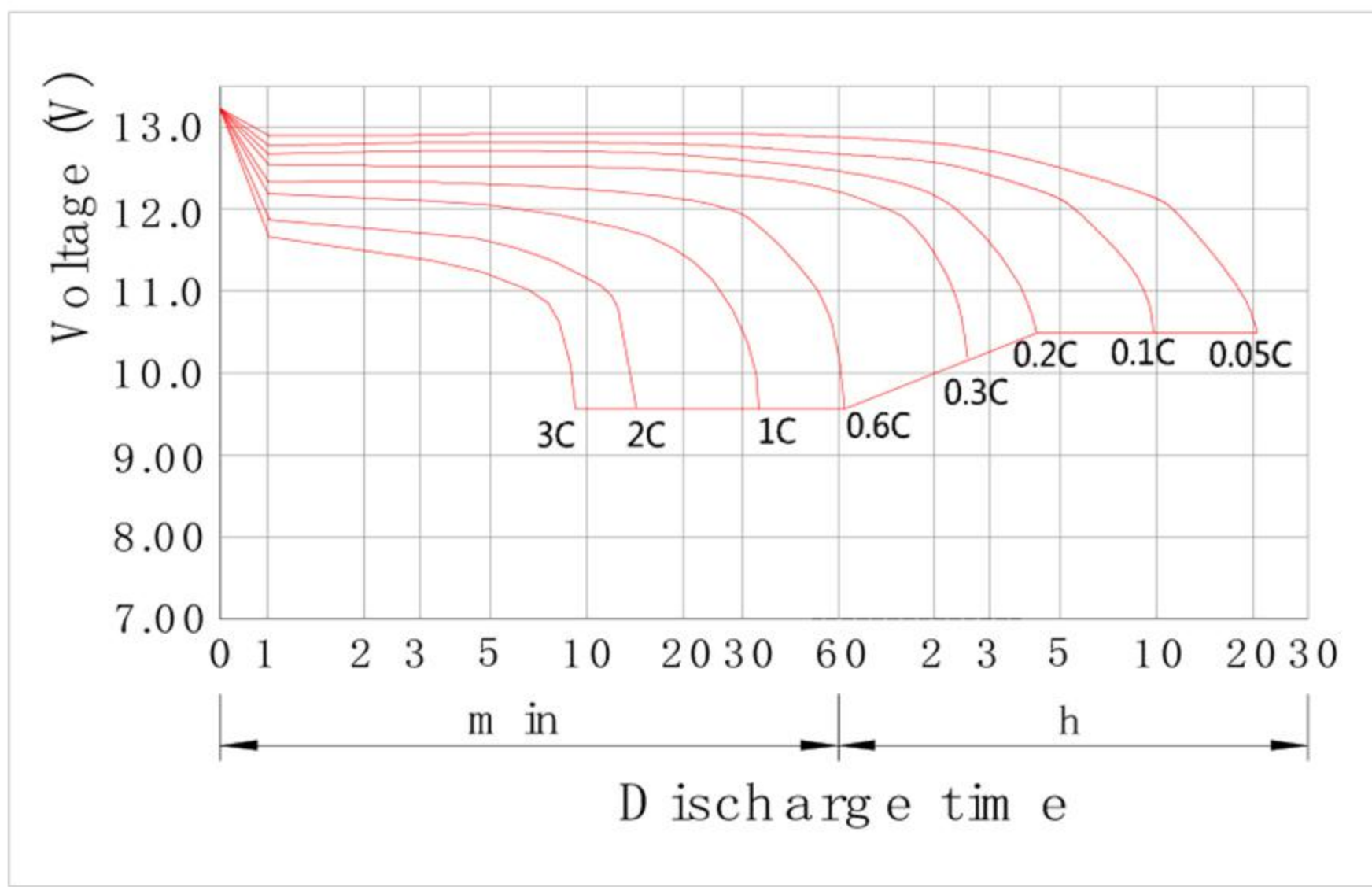

Charging Characteristics(25°C)

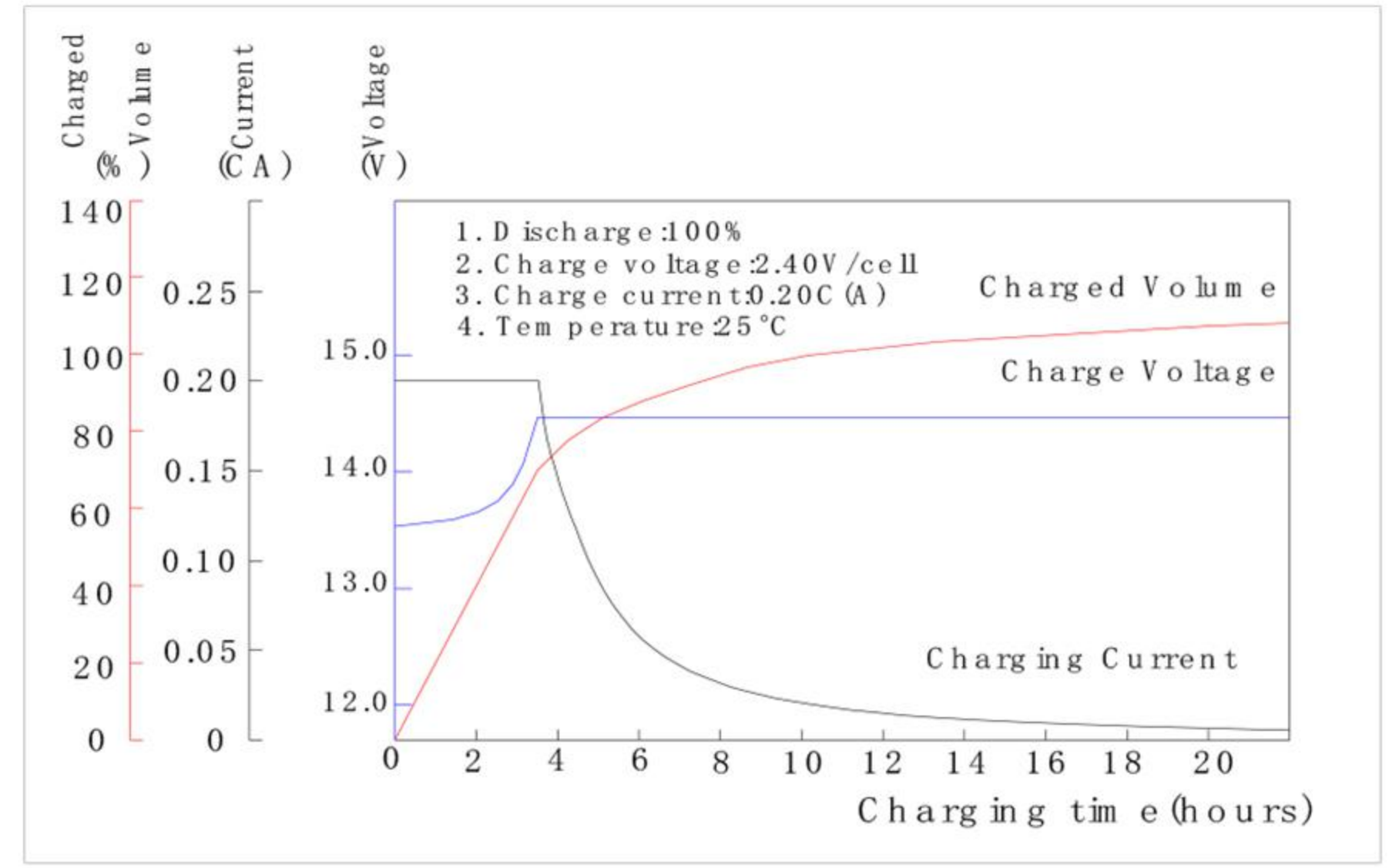

Effect of Temperature on Capacity

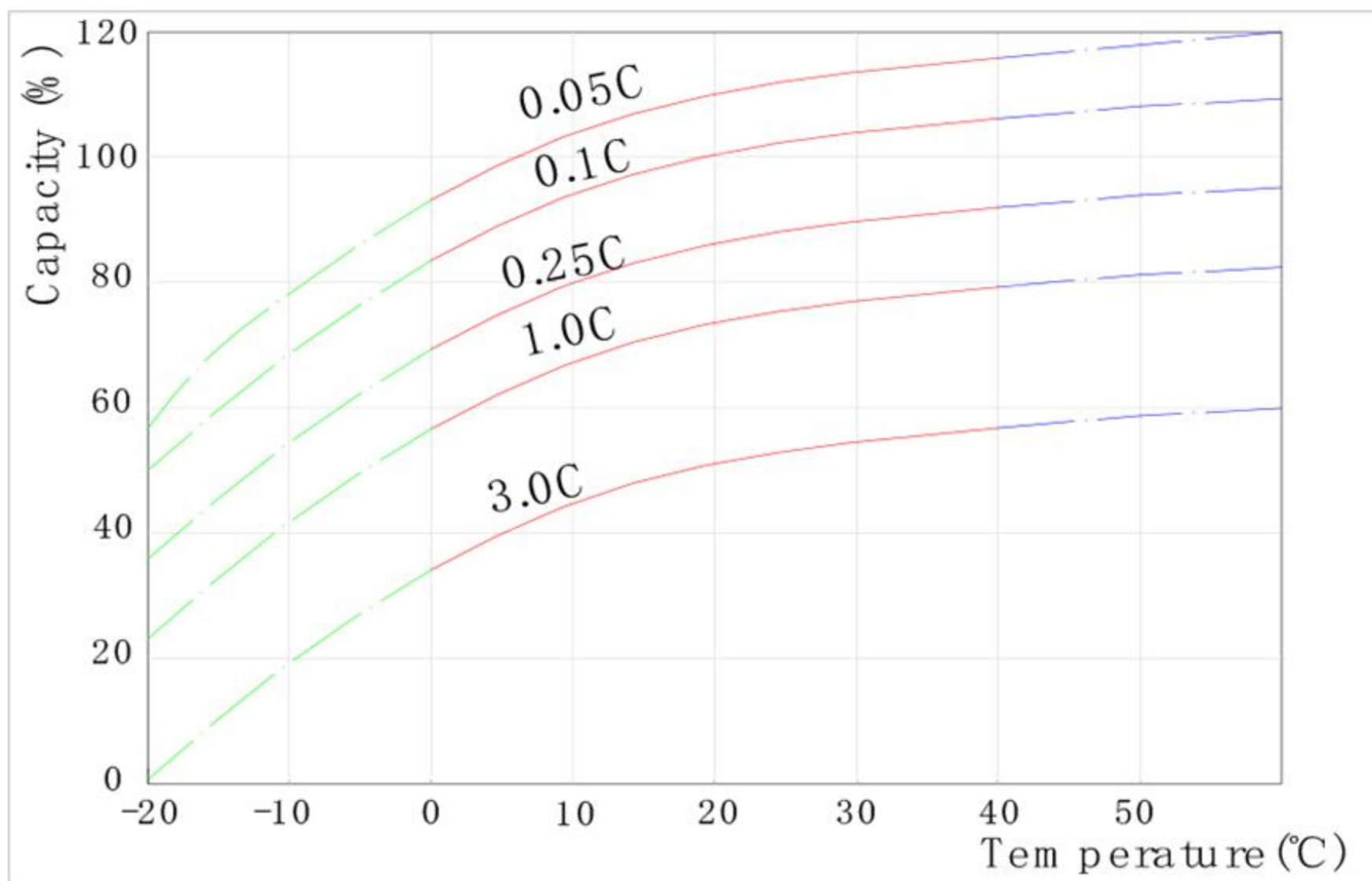

Self-discharge Characteristics

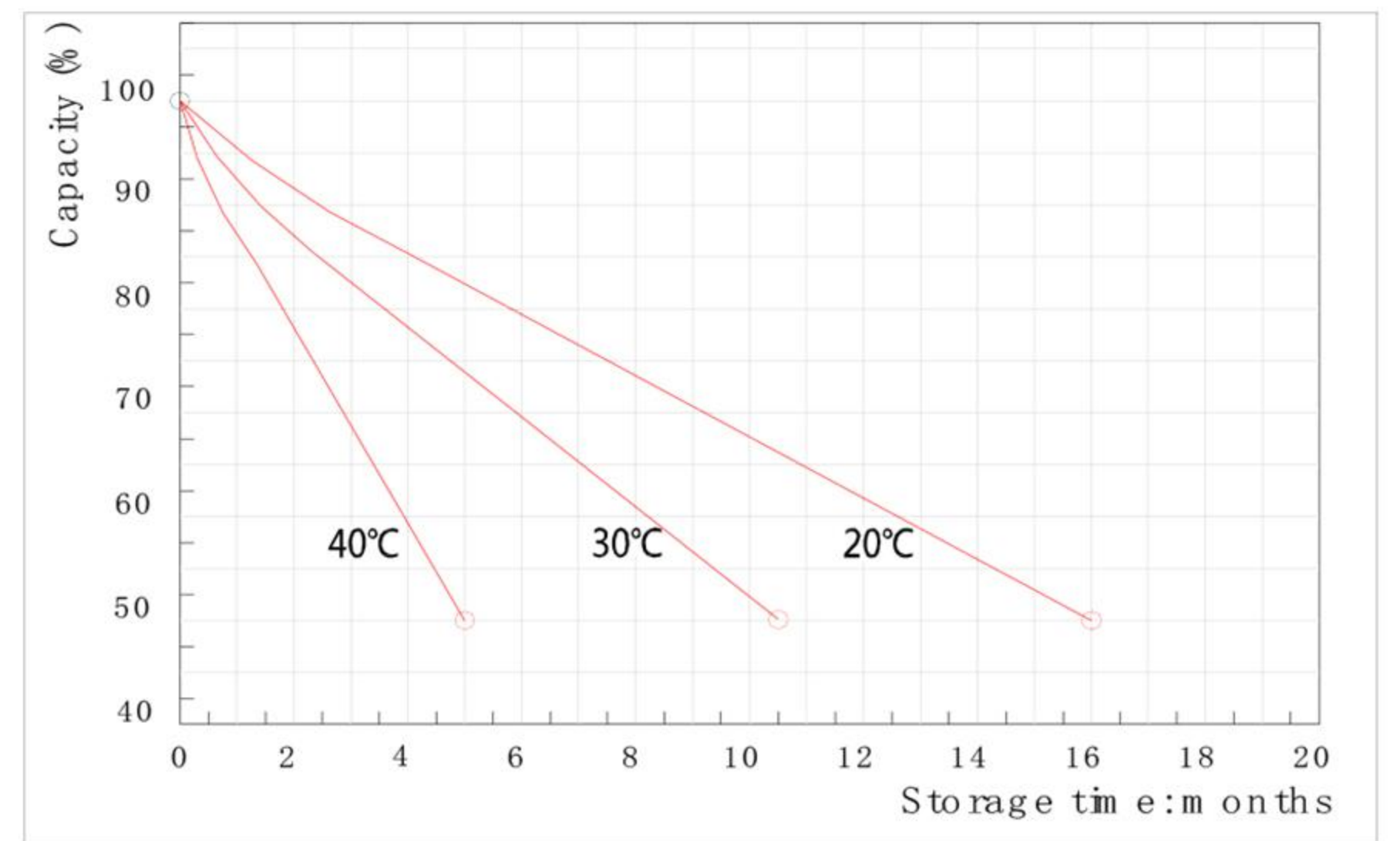

The Relationship for Open Circuit Voltage and Residual Capacity (25°C)

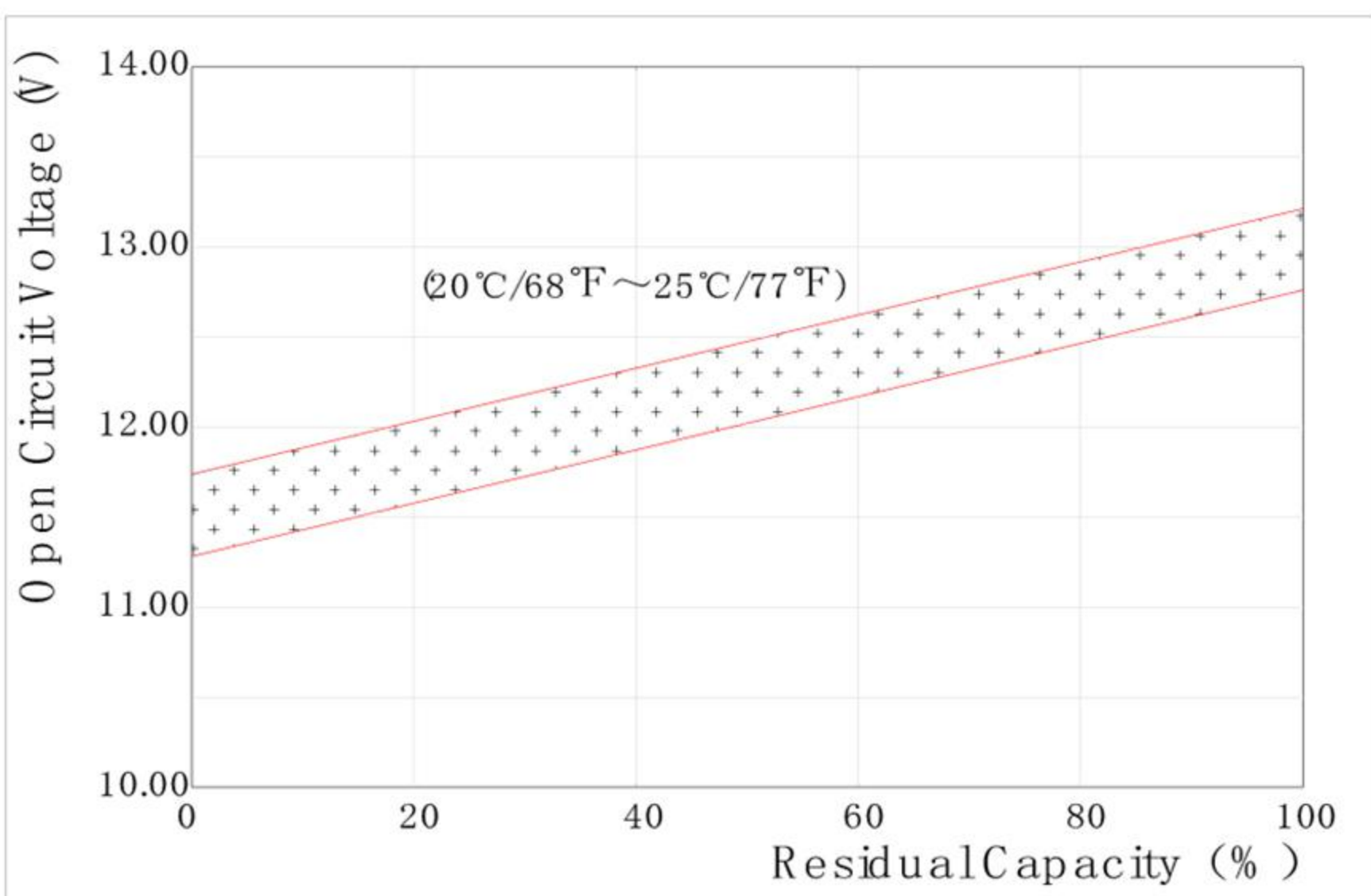

The Relationship for Charging Voltage and Temperature

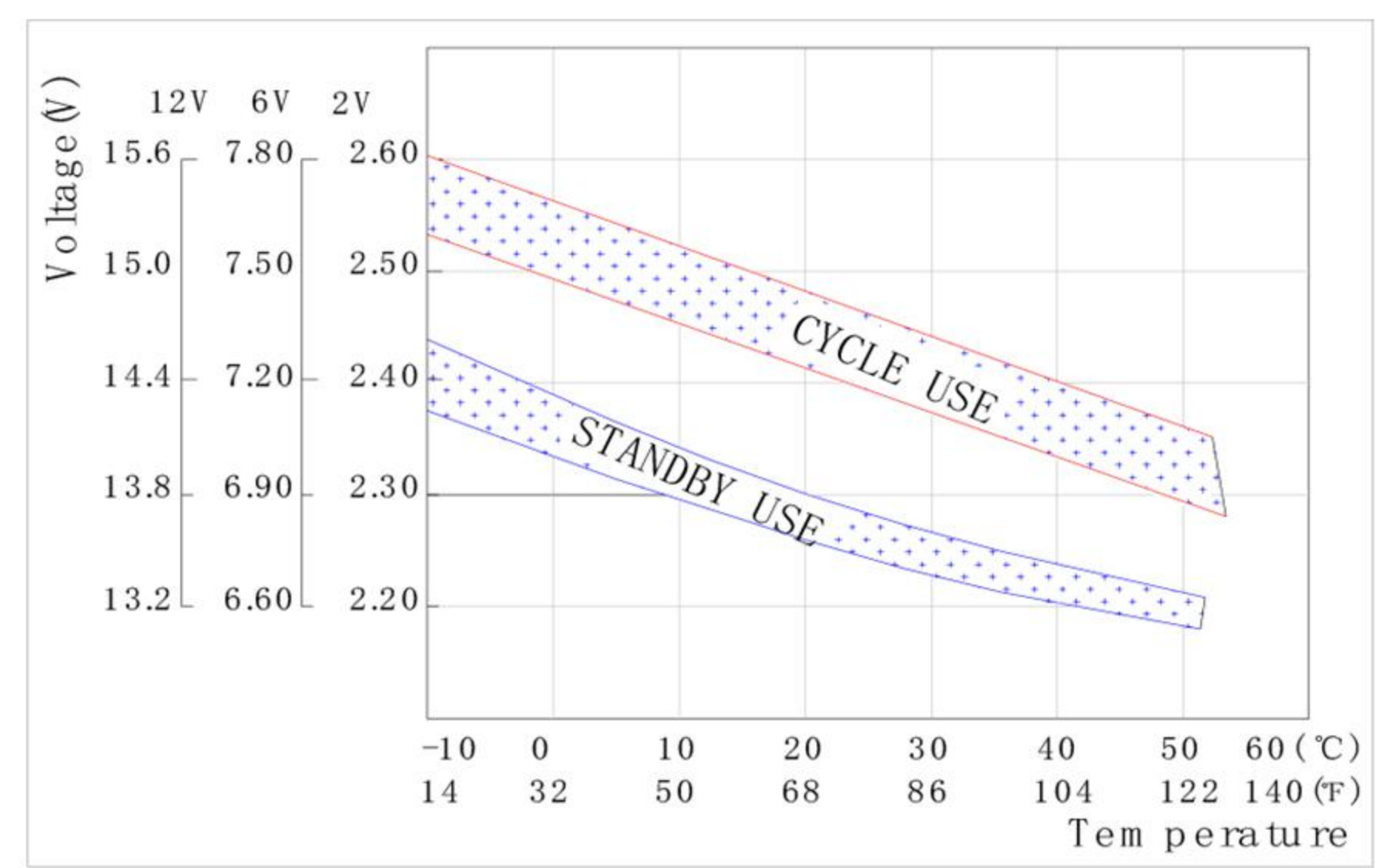

Floating Life on Temperature

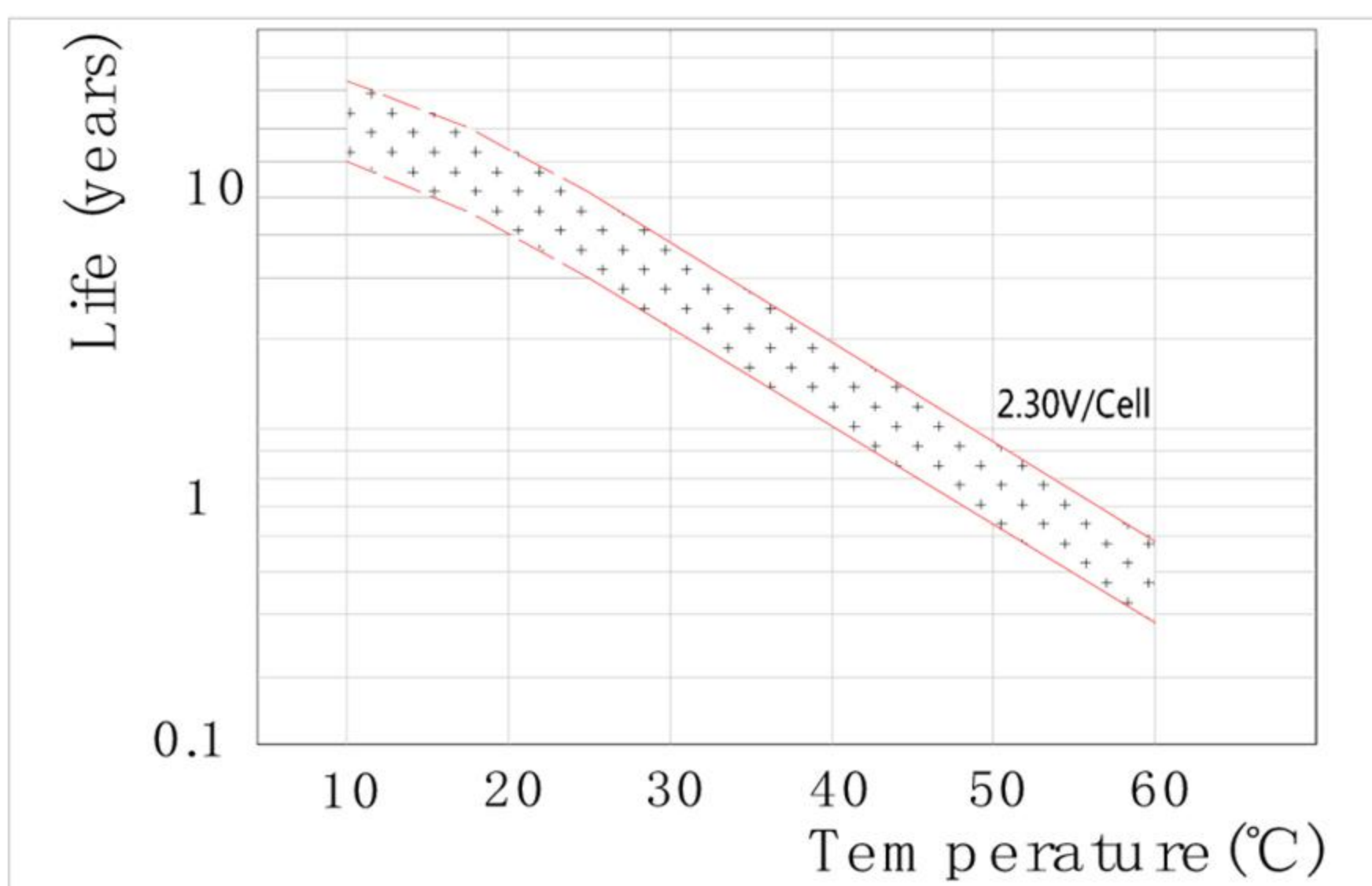

Cycle Life on D.O.D(25°C)

